

DIMENSIONING NOTE:
 ALL DIMENSIONS SHOWN ARE TO FINISHED SURFACES.
 MAKE ADJUSTMENTS FOR RAW STUDS OR SUBFLOORS.
 SET DOORS & SWITCHES FOR WIDE TRIM. SEE TRIM SCHEDULE.

FIXTURE NOTES:
 ITEMS MAY NOT HAVE BEEN SELECTED AT TIME OF DRAWING.
 CONFIRM REQUIREMENTS WITH SPEC SHEETS AS PURCHASED.
 ALL TOILET FEEDS TO BE LOCATED ON THE WALL.
 DO NOT USE FX TUBING FOR VISIBLE TOILET FEEDS.
 AVOID CONFLICTS WITH VENT STACKS & SCONCES & MED. CABS.
 CHECK FOR SPECIAL HEIGHTS DUE TO TILE WORK ON WALLS.
 EXHAUST FANS AND LIGHTS TO BE ON SEPARATE SWITCHES.
 -PLEASE ADVISE DESIGNER IF CONDITIONS ARE NOT AS EXPECTED.

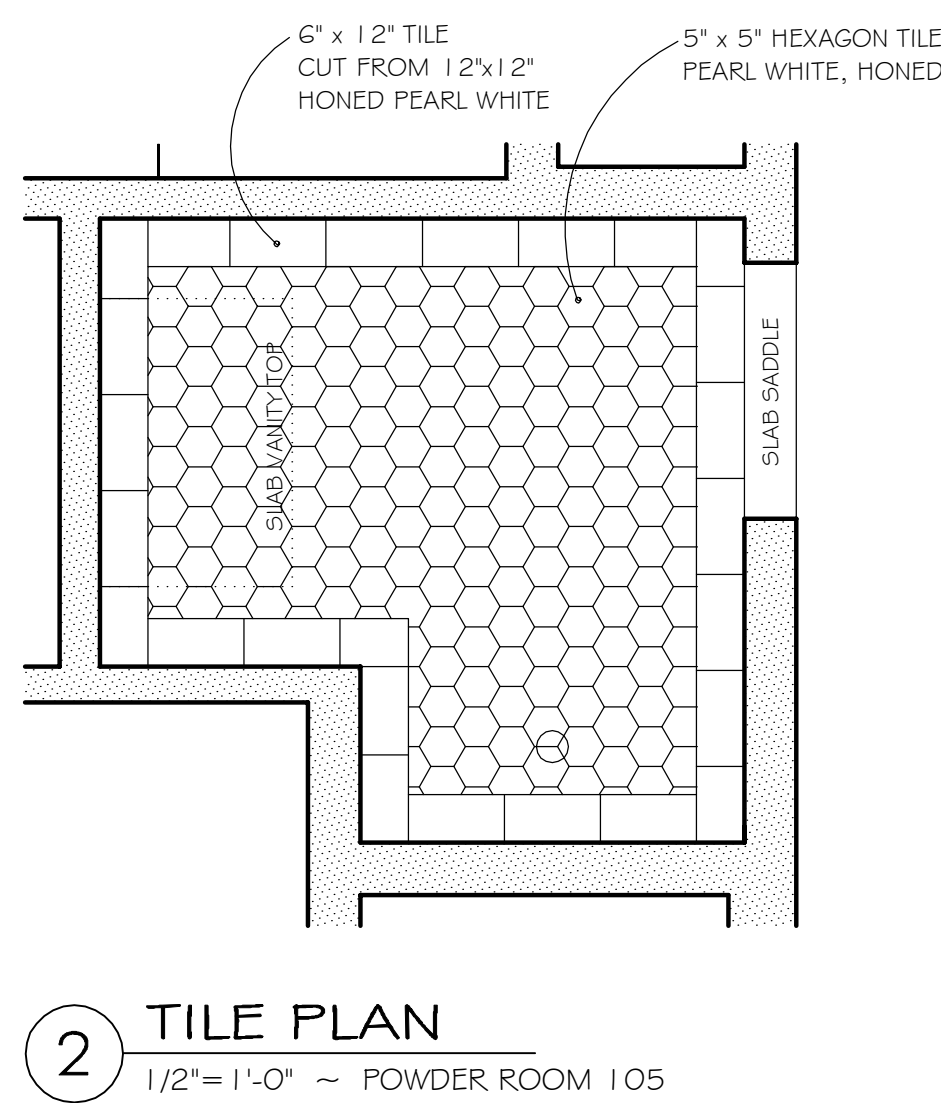
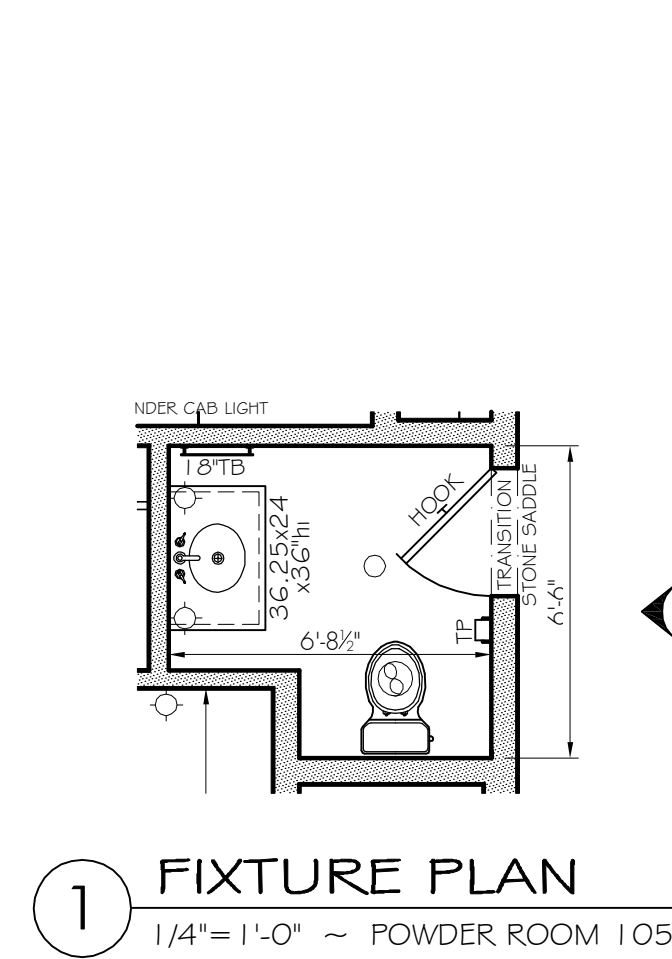

TILE KEY	
5" x 5" HEXAGON TILE PEARL WHITE, HONED AM8G27H	FLOOR
6" x 12" TILE CUT FROM 12"x12" HONED PEARL WHITE AM8G04H	FLOOR
4" x 12" CERAMIC UAO69Y9AV058	(1) WALL
1/2" x 12" PENCIL POLISHED CARRERA MED-CGA1 2PENP	(1) WALL
2" x 12" CHAIR RAIL POLISHED CARRERA MED-CGA2 12CHRP	MIRROR
MAPEI WARM GREY UNSANDED MED-89310	GROUT
WHITE CARRERA POLISHED	SLABS & SADDLE

HARDWARE FINISH: POLISHED CHROME
 PORCELAIN COLOR: WHITE
 CABINET STYLE:
 CABINETRY FINISH: PAINT WHITE
 TRIMS FINISH: PAINTED

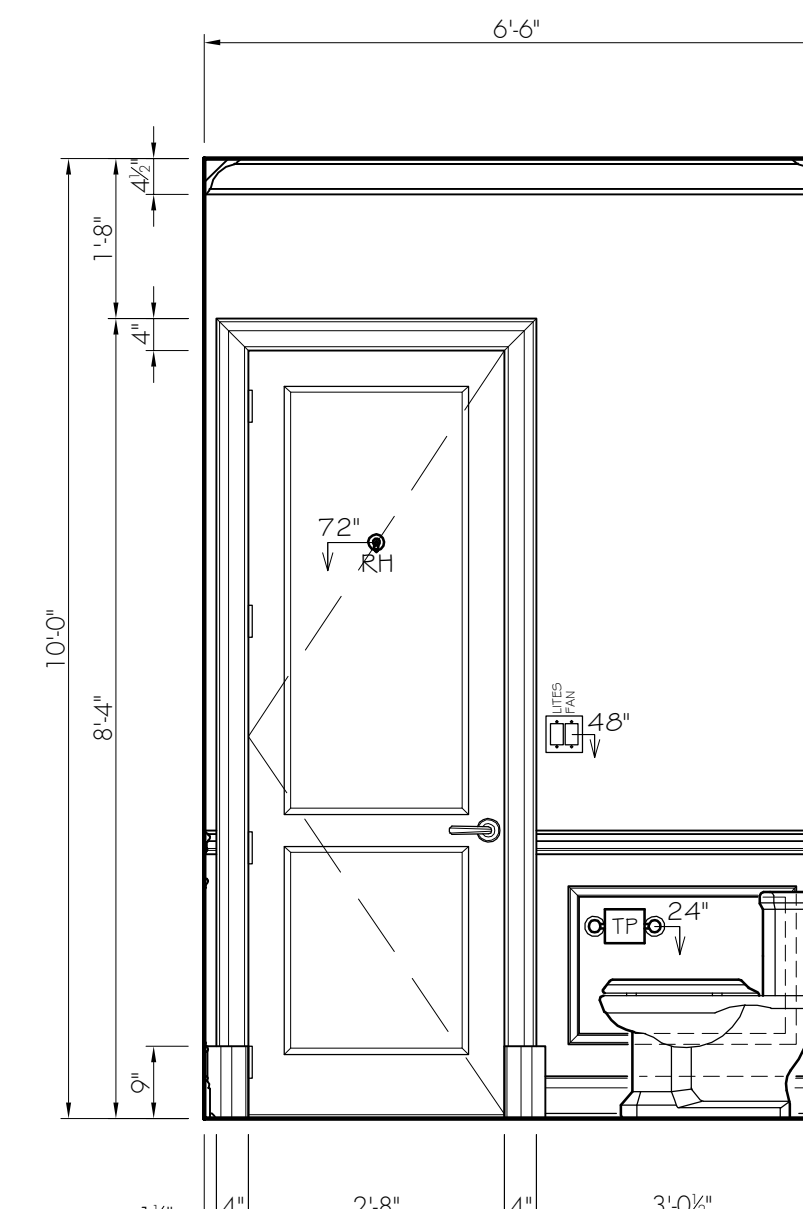
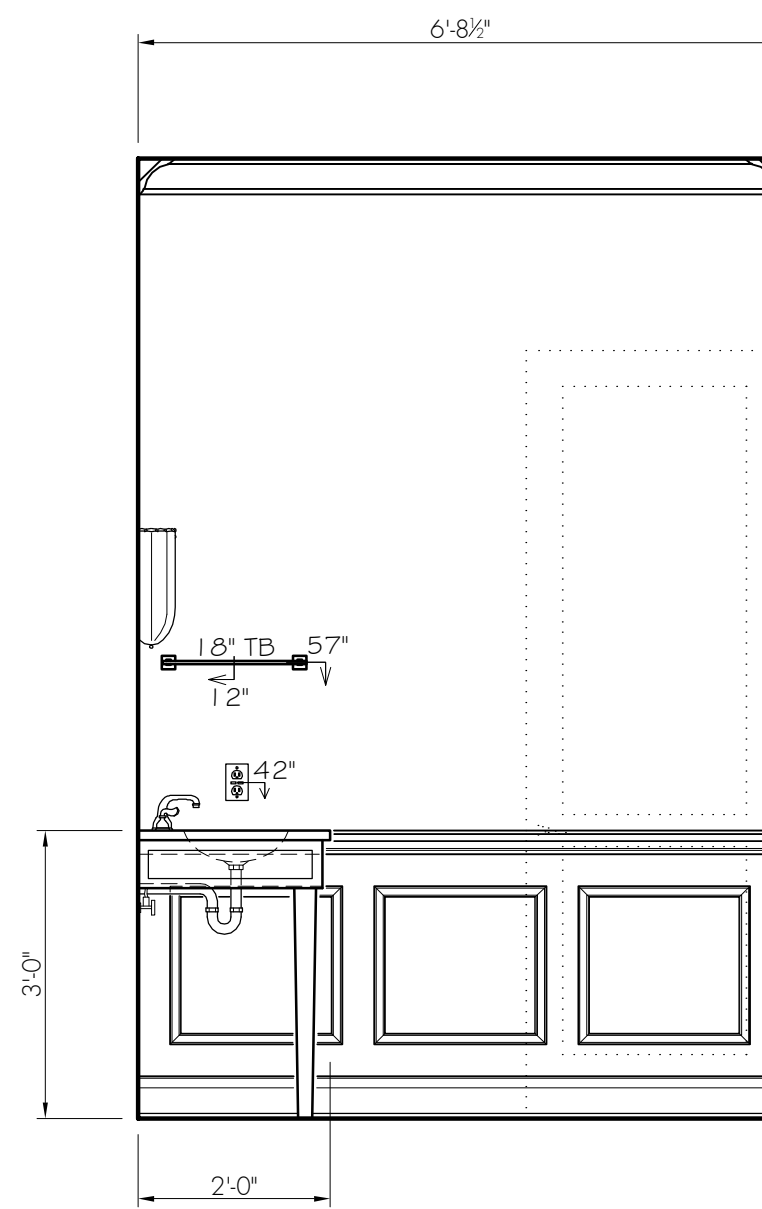
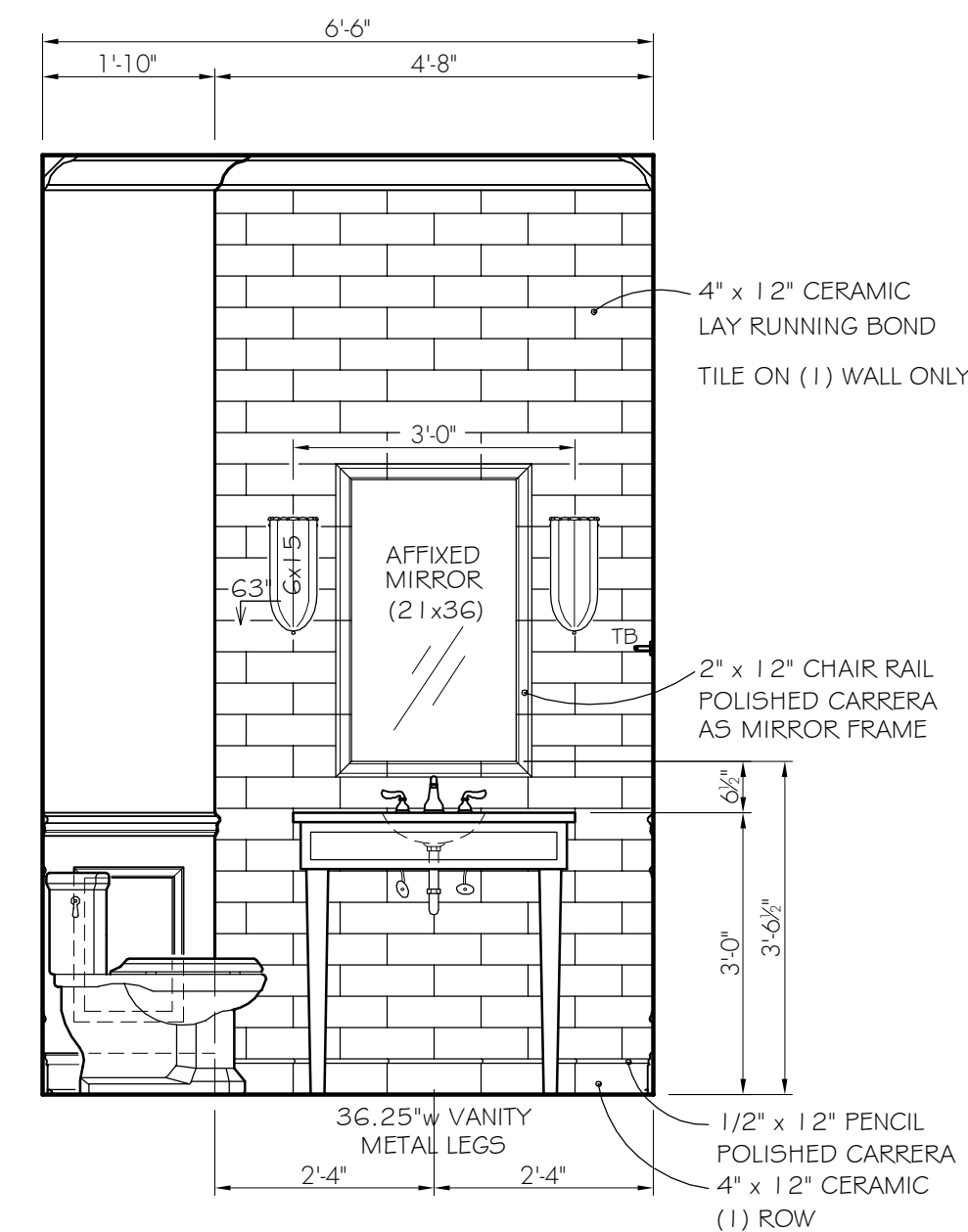
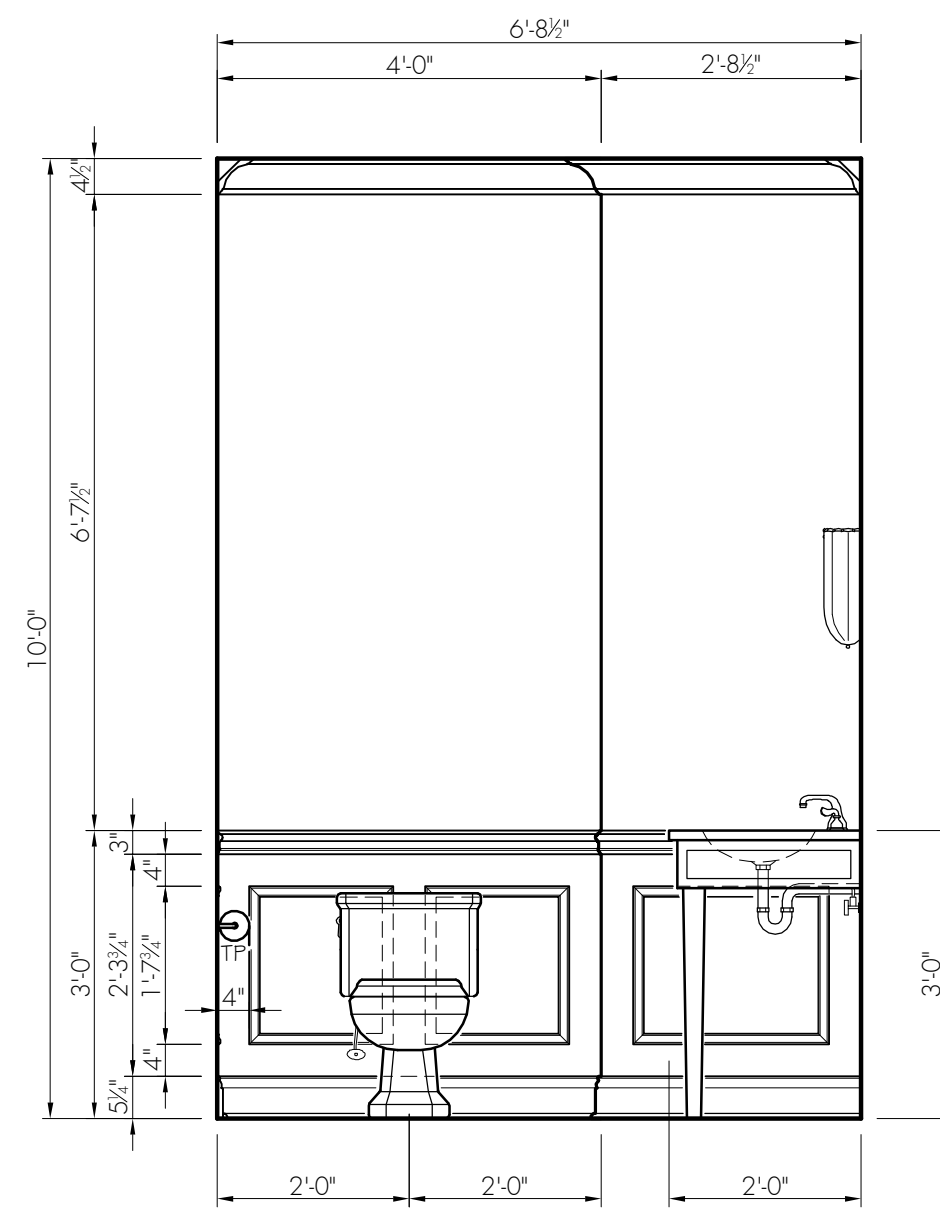
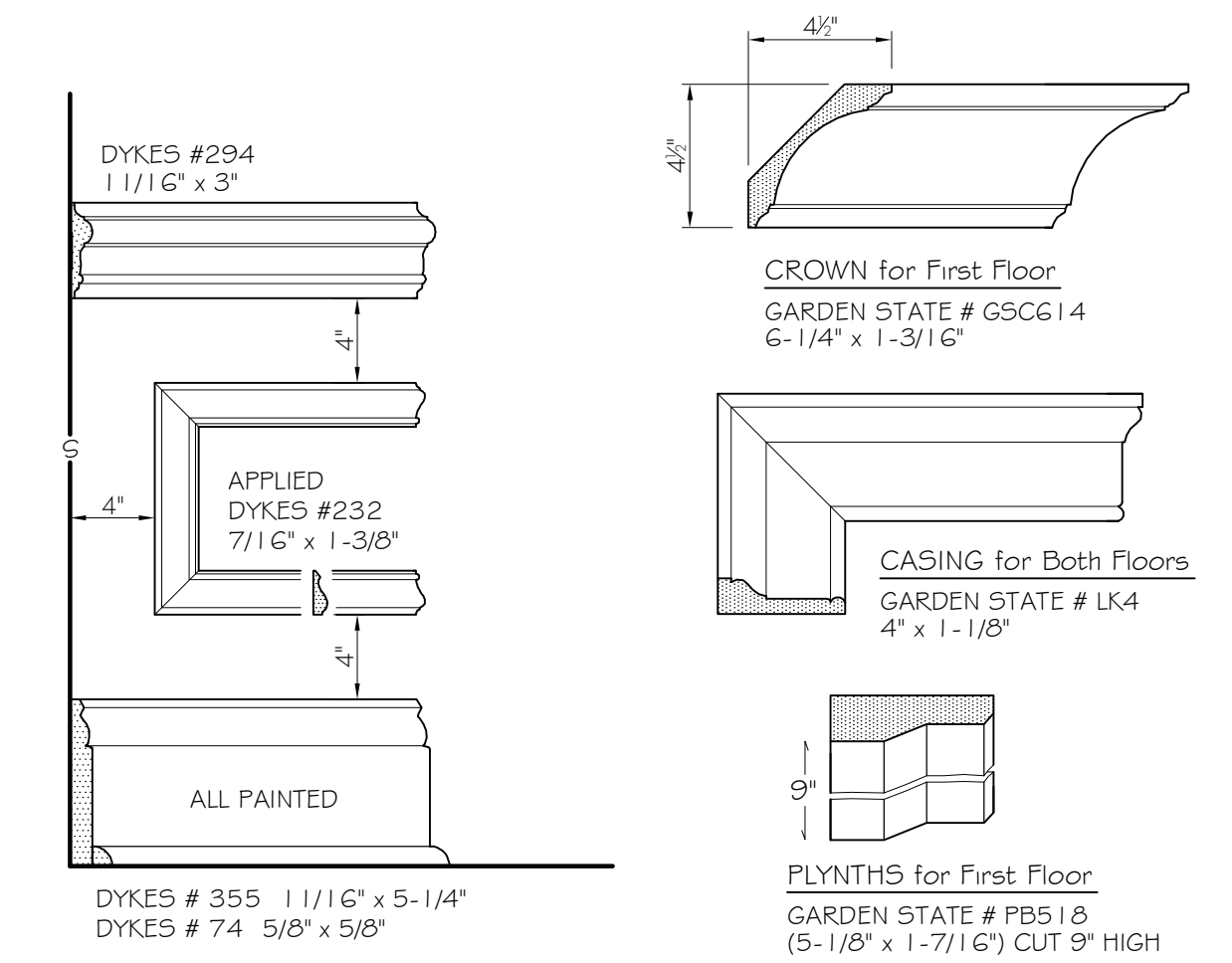

ROOM LIST	
001 TBD	201 UPPER FOYER
002 TBD	202 UPPER GALLERY
003 TBD	203 HOMEWORK RM
004 TBD	204 LAUNDRY
005 TBD	205 GUEST RM TWO
006 TBD	206 SHARED BATH
007 TBD	207 ISABELLA'S BEDRM
008 TBD	208 MASTER BATH
009 MECHL RM	209 MASTER COMMODE
010 STORAGE	210 MASTER PASSAGE
011 TBD	211 MASTER WIC
	212 MASTER BEDRM
	213 SITTING RM
	214 ALEXANDRA'S BEDRM
101 FOYER	215 ALEXANDRA'S BATH
101a COATS ONE	216 MANN CAVE (ATTIC)
101b COATS TWO	
102 MAIN GALLERY	EX-1 OPEN TERRACE
103 GREAT ROOM	EX-2 COVERED TERR.
104 LIBRARY	EX-3 PORTE COCHERE
105 POWDER ROOM	EX-4 FRONT PORCH
106 DINING ROOM	EX-5 REAR PORCH
107 BUTLER'S PANTRY	GA-1 2-CAR GARAGE
108 PANTRY	GA-2 1-CAR GARAGE
109 KITCHEN	ST-1 STAIR FOYER
110 BREAKFAST	ST-2 STAIR BSMNT
111 MUD ROOM	ST-3 STAIR MUD RM
112 BACK HALL	ST-4 STAIR HOMEWRK
113 GUEST BATH	ST-5 STAIR GARAGE
114 GUEST RM ONE	ST-6 STAIR ATTIC
115 POOL POWDER RM	

No.	Date	Revision Description
9	1/19/16	TOWEL BAR WAS TOWEL RING
8	1/13/16	CORRECTED PART NUMBER 4x12
7	1/12/16	CHANGED TILE, ADD WAINSCOT
6	12/18/15	UPDATED LIGHTING
5	10/21/15	ADDED SLAB THICKNESS
4	8/31/15	ADDED SELECTED TRIMS, VANITY
3	7/21/15	SCONCES, VANITY
2	7/31/15	ADDED TILE
1	6/25/15	FIRST ISSUED

Diane Boyer Interiors
 271 Grove Avenue
 Verona, New Jersey 07044
 Phone: (973) 857-5900 Fax: (973) 857-5915

PROJECT: CLIENT RESIDENCE
 HOMETOWN, NEW JERSEY

TITLE: ROOM DETAILS
 POWDER ROOM 105

Dwg. By: JDP	Drawing Number: EL-105	Version: NINE
Scale: AS NOTED		

PRELIMINARY



THIS DRAWING IS FOR DESIGN PURPOSES ONLY
 CONTRACTORS MUST VISIT JOB SITE AND VERIFY ALL EXISTING CONDITIONS
 © BASE DRAWINGS FOR CONSULTANT USE PROVIDED BY VIRGONA & VIRGONA ARCHITECTS